

# ЖАСМІН / JASMINE

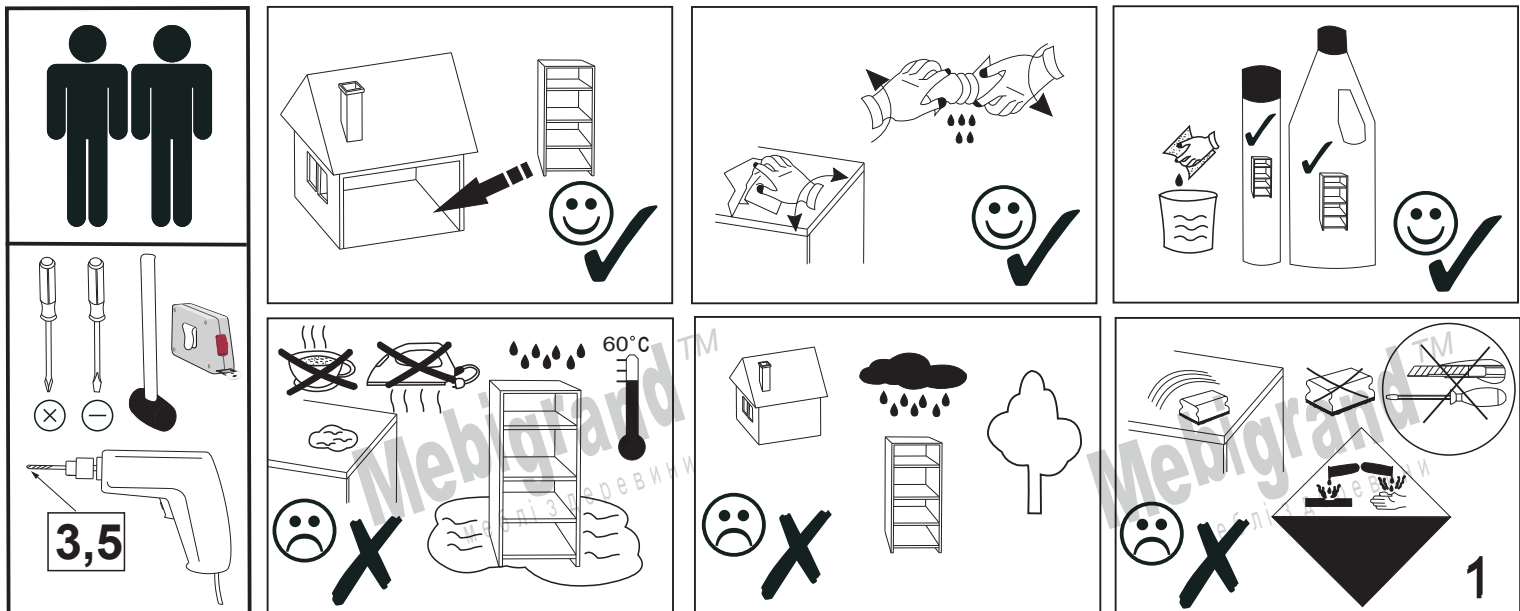

1.

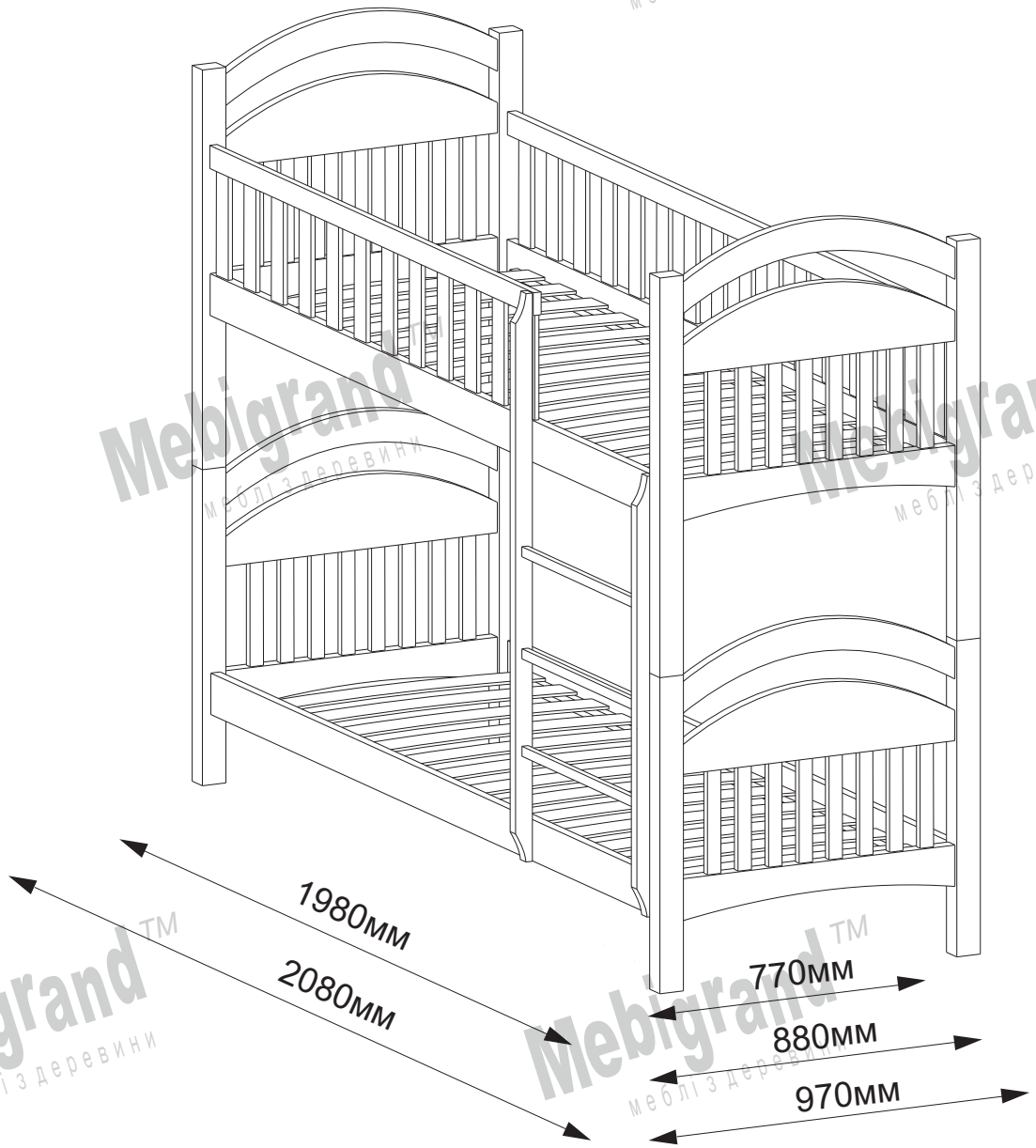
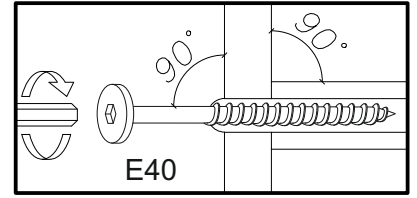
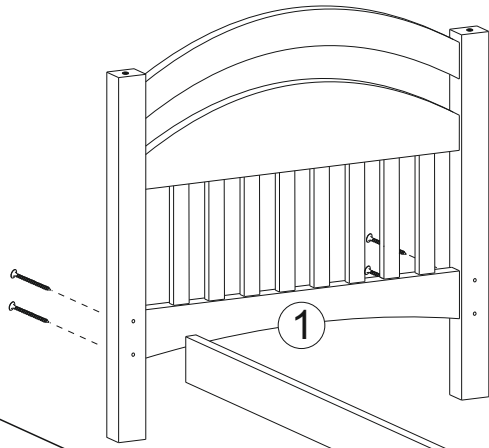

2.

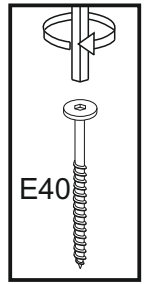
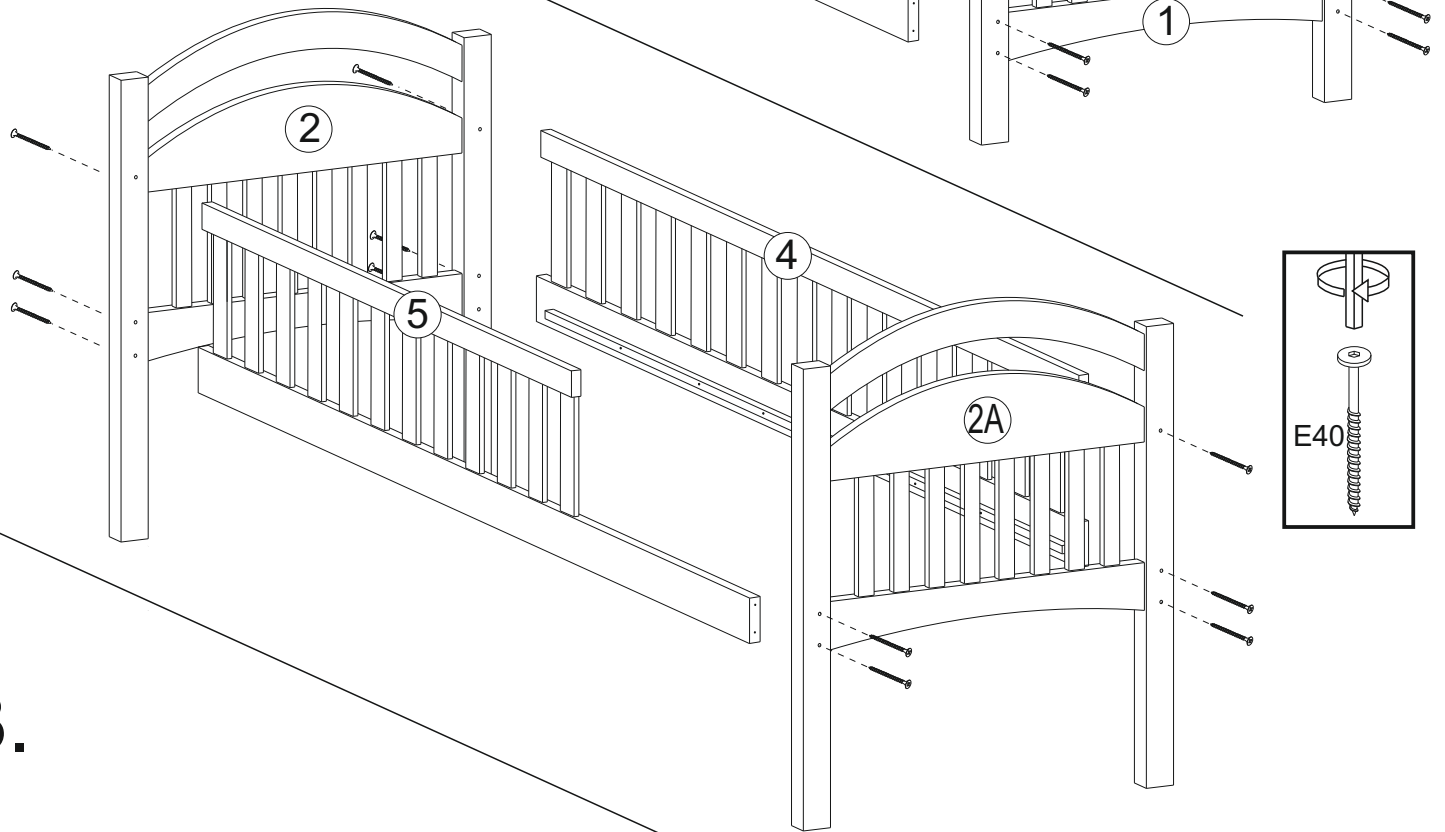
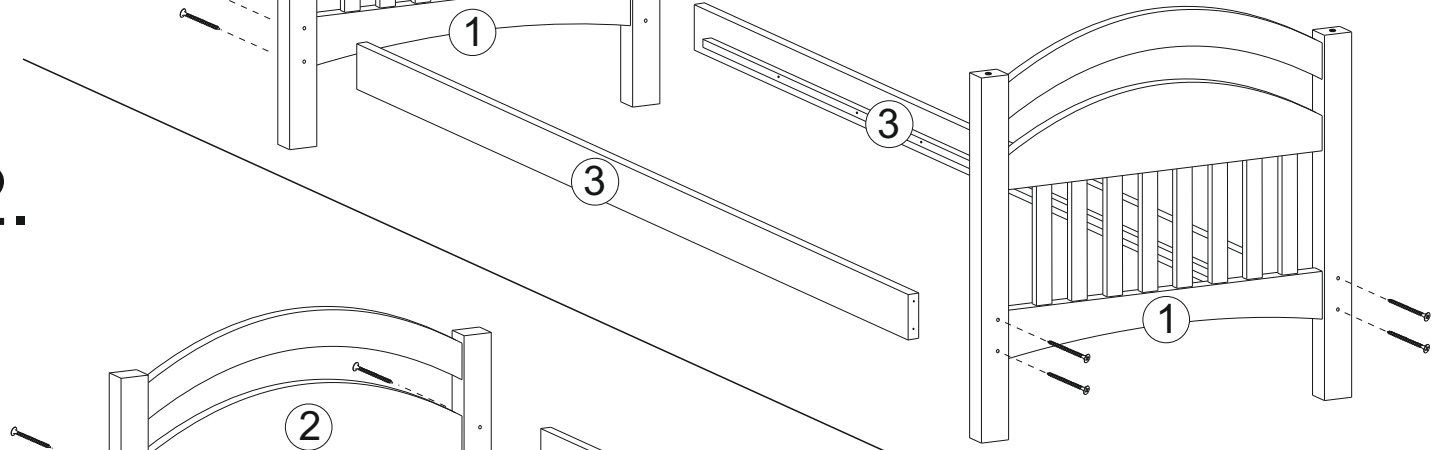

3.

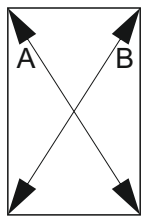

A=B

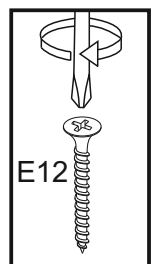
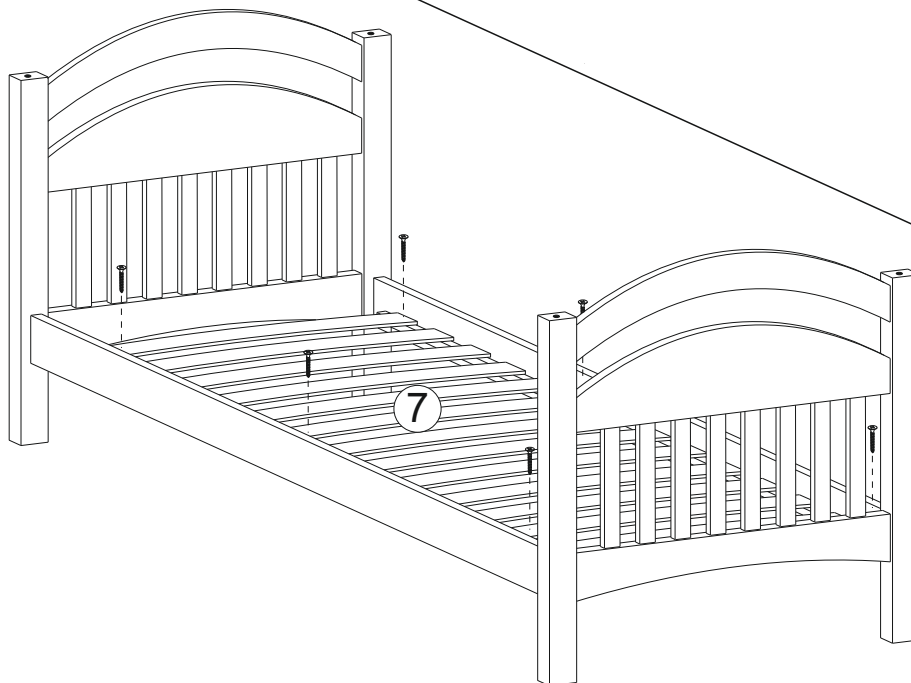

4.

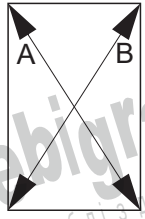

A=B

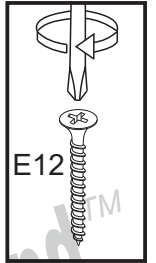
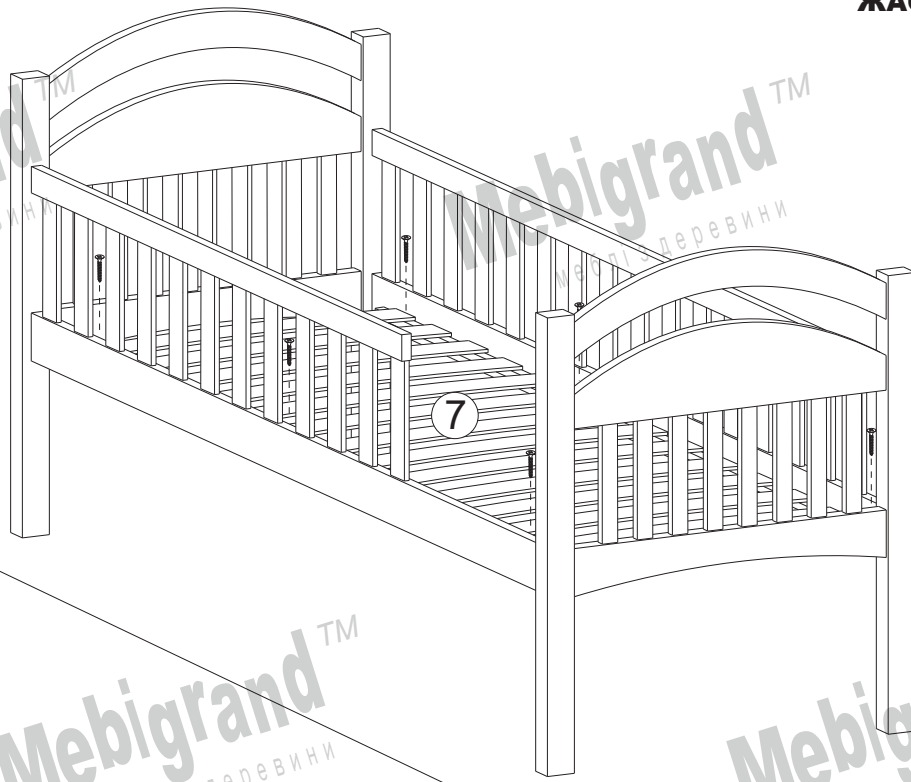

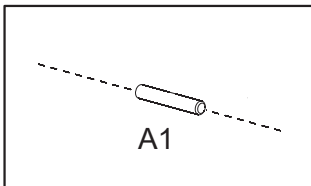
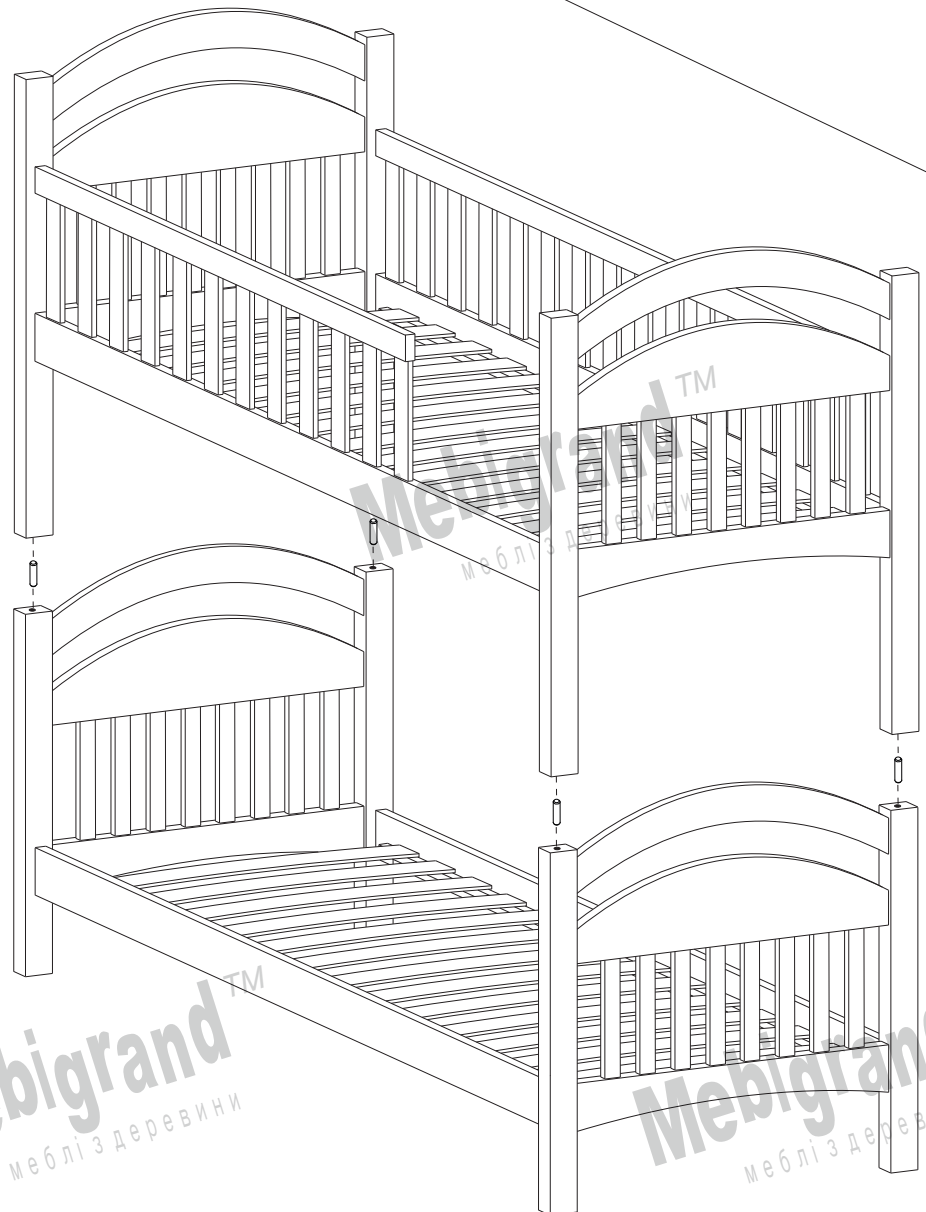

5.

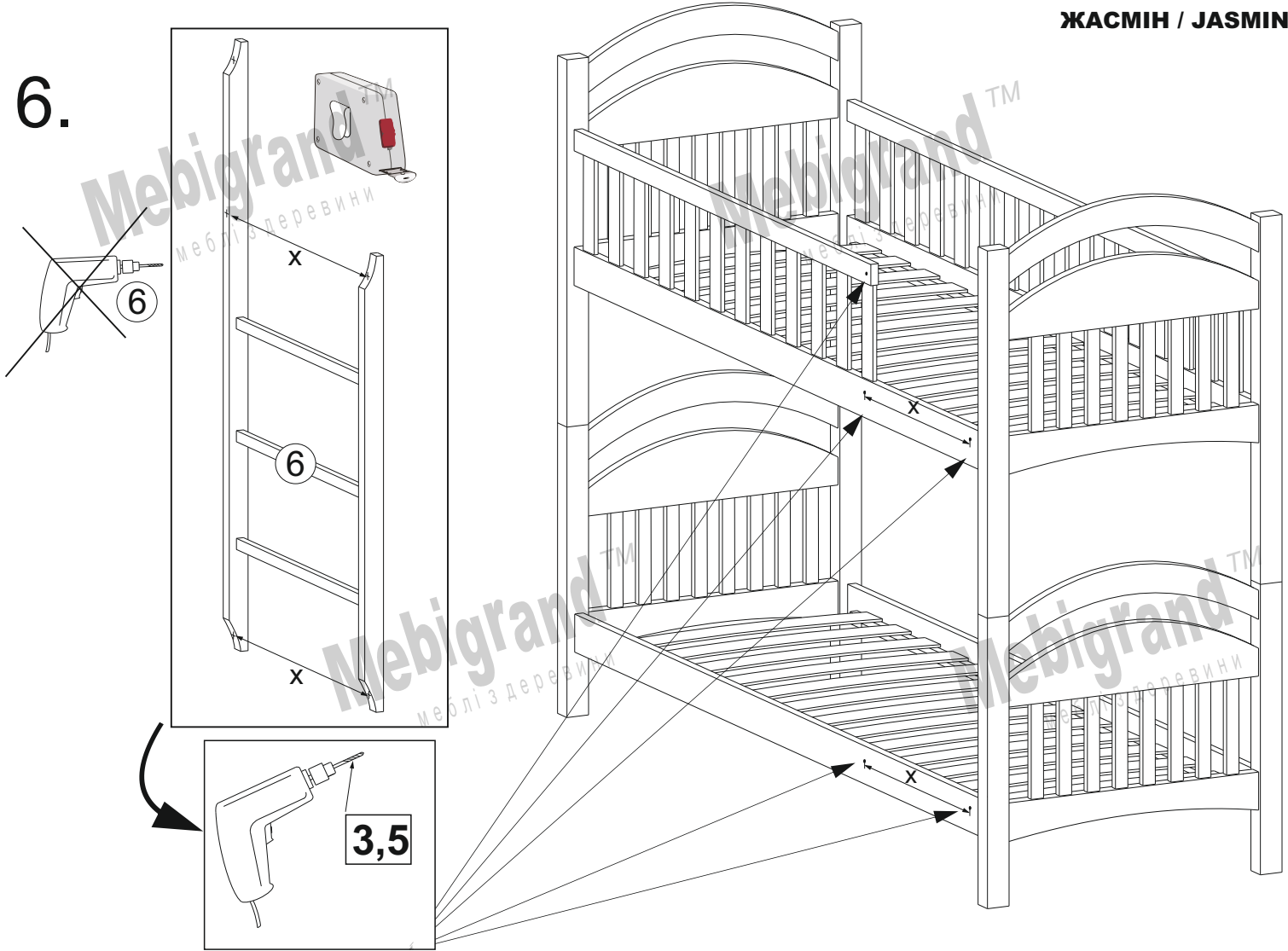

6.

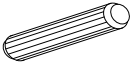
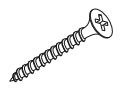
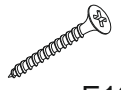

| №    | x   |
|------|-----|
| 1    | 2   |
| 2+2A | 1+1 |
| 3    | 2   |
| 4    | 1   |
| 5    | 1   |
| 6    | 1   |
| 7    | 2   |

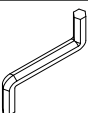
|            |   |
|------------|---|
| 4x         |  |
| ∅ 8x35мм   | A1  |
| 12x        |  |
| ∅ 3.5x25мм | E12   |
| 5x         |  |
| ∅ 3.5x45   | E16   |
| 19x        |  |
| ∅ 6x80мм   | E40   |
| 1x         |  |
|            | K1  |

7.

