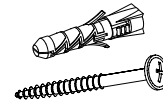
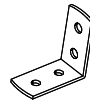
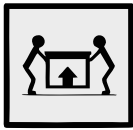
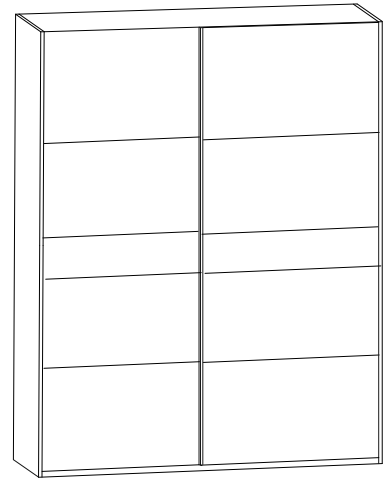
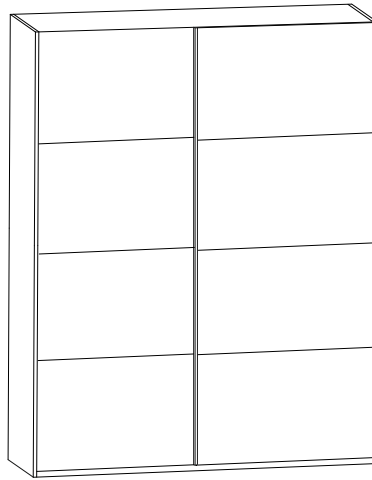
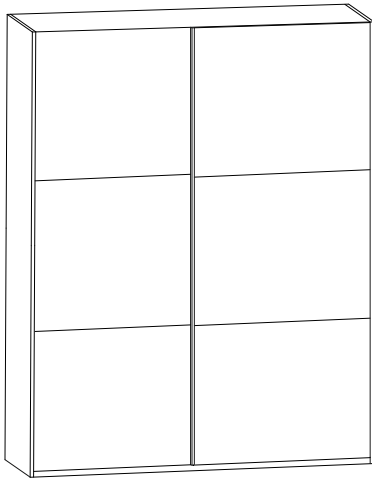

ENG

G-Kaiser sliding wardrobe

UA

G-Кайзер розсувна шафа**2400x1800x600 mm****To avoid falling**

we recommend fixing the product to the wall using **corners** or **double-sided tape**

Purchase separately.

ENG

Щоб уникнути падіння виробу

рекомендуємо закріпити його до стіни **кутиками** чи **двосторонньою стрічкою**.

Необхідно придбати окремо.

UA

ENG



UA

RULES FOR USE AND CARE OF FURNITURE

1. Use furniture only in dry rooms protected from the effects of weather conditions.
2. Install with suitable tools according to these assembly instructions.
3. Try to assemble as close to the location as possible.
4. The body is assembling in a horizontal position.
5. Before moving furniture, make sure that it is not loaded with items.
Caution: moving furniture may damage it. When moving, hold on to vertical elements only; moving furniture by horizontal parts can break the product.
6. Overloading the furniture can damage it.
7. From time to time check the fittings and their correct position.
8. Wipe the furniture surface only with a slightly damp cloth or paper towels. Do not use chemical cleaning agents other than those specifically made for this.

ПРАВИЛА ВИКОРИСТАННЯ ТА ДОГЛЯДУ ЗА МЕБЛЯМИ

1. Використовуйте меблі тільки в сухих приміщеннях, захищених від впливу погодних умов.
2. Виконуйте установку за допомогою відповідних інструментів відповідно до даної інструкції зі складання.
3. Намагайтеся проводити збірку якомога ближче до місця використання.
4. Збірка корпусу здійснюється в горизонтальному положенні.
5. Перед переміщенням меблів переконайтеся, що вони не навантажені.
Увага: переміщення меблів може привести до її пошкодження. При переміщенні тримайтеся тільки за вертикальні елементи, переміщаючи меблі за горизонтальні деталі ви можете зламати виріб.
6. Перевантаження меблів може привести до їх пошкодження.
7. Час від часу перевіряйте кріплення і правильність їх положення.
8. Протирайте поверхню меблів тільки добре віджатою вологою тканиною або ж паперовими рушниками. Не використовуйте хімічні засоби для очищення, крім спеціально для цього призначених.

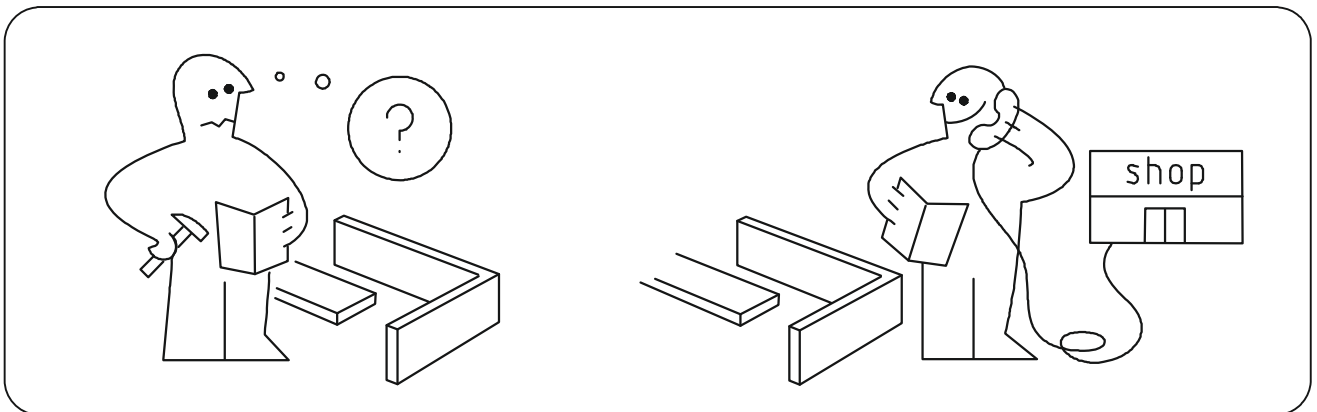
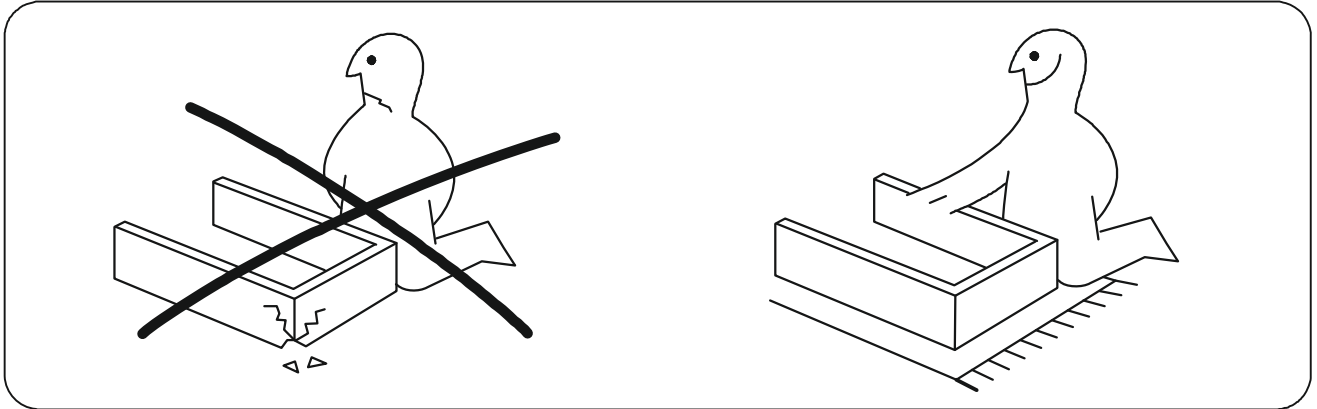
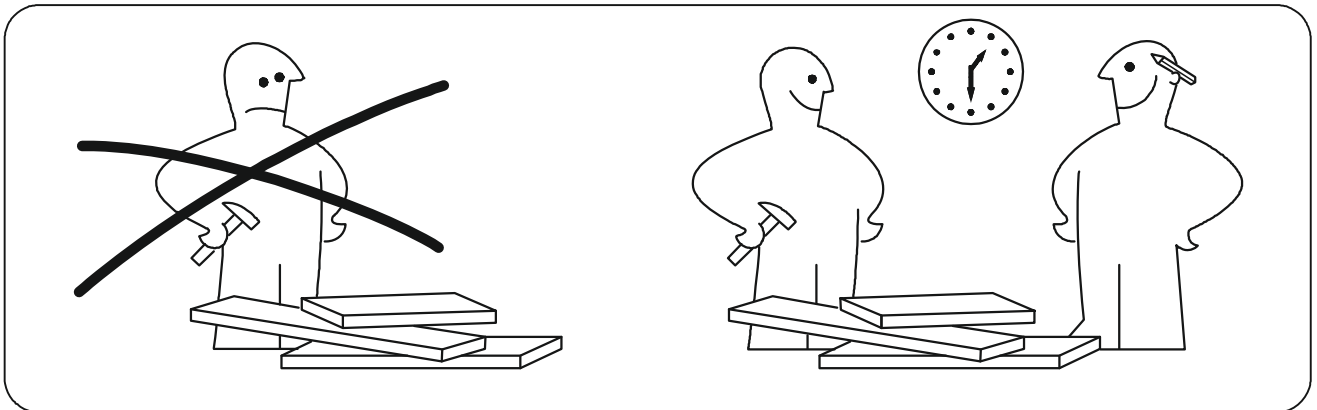
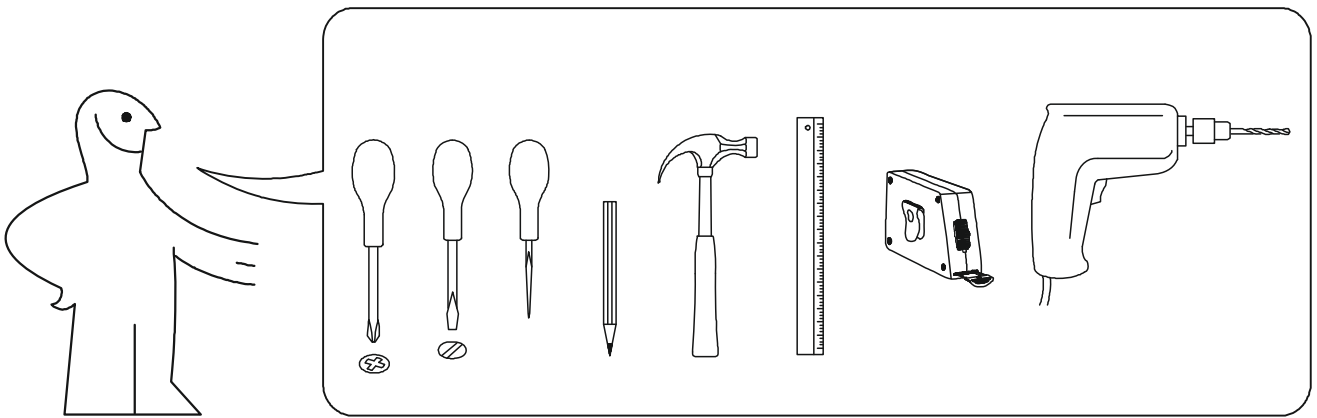

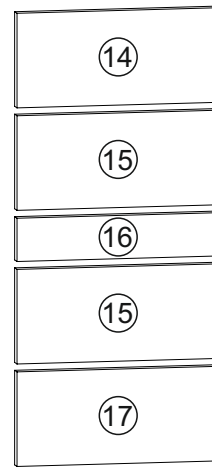
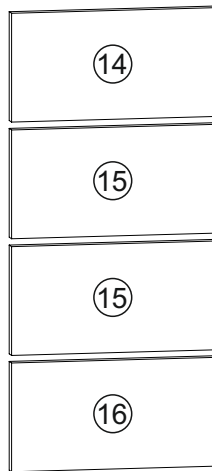
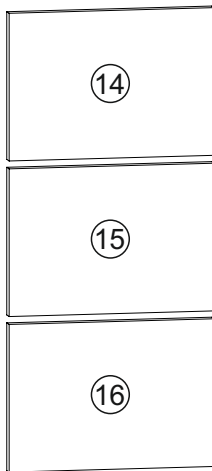
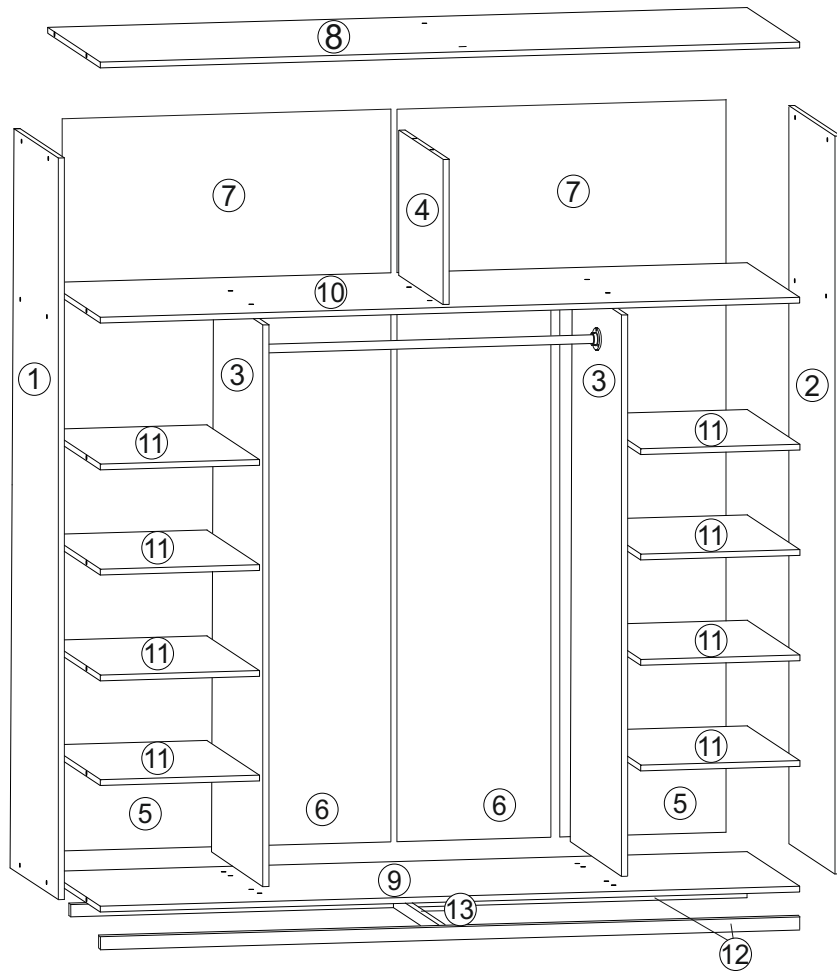

1x up1	1x dp1	3x ph1	1x cr1	1x	2x n906	6x al1
11x c3	8/12/16x r20	26x zn1	32x r11	24x $\varnothing 7 \times 50$ mm e32	60x s3	1x z1
20x $\varnothing 8 \times 30$ mm f1	12/18/24x $\varnothing 8 \times 60$ mm f6	28x $\varnothing 6 \times 13$ mm e3	156x $\varnothing 3,5 \times 16$ mm p38	4x $\varnothing 4 \times 25$ mm p40	2x $\varnothing 4 \times 40$ mm p42	1x l1

1

11x  c3

2x 

29x  p38
φ3,5x16 mm

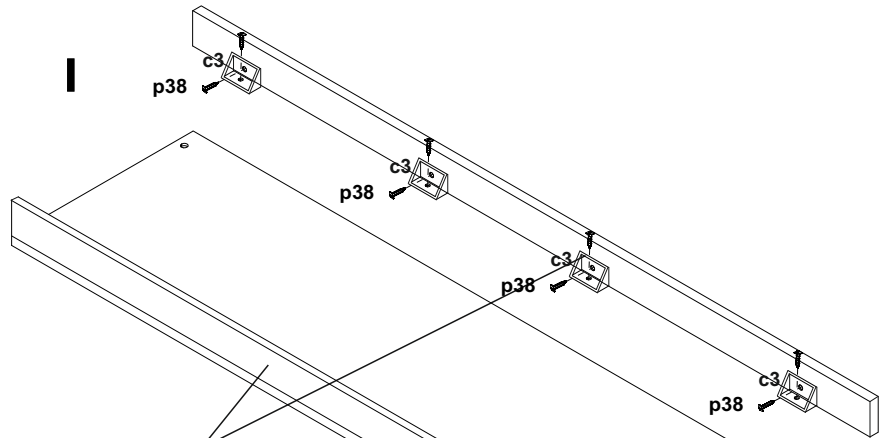

II

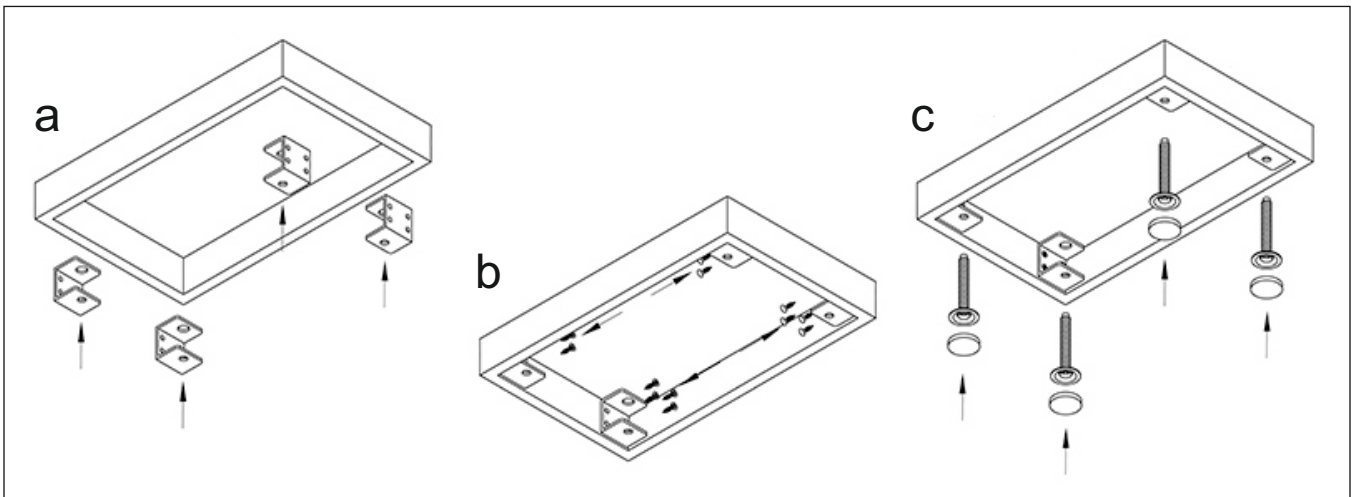
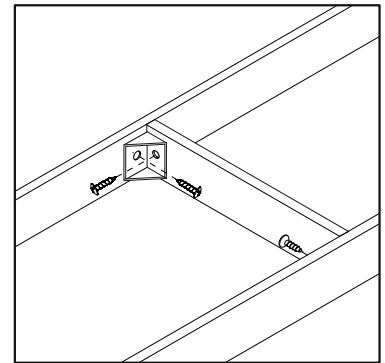
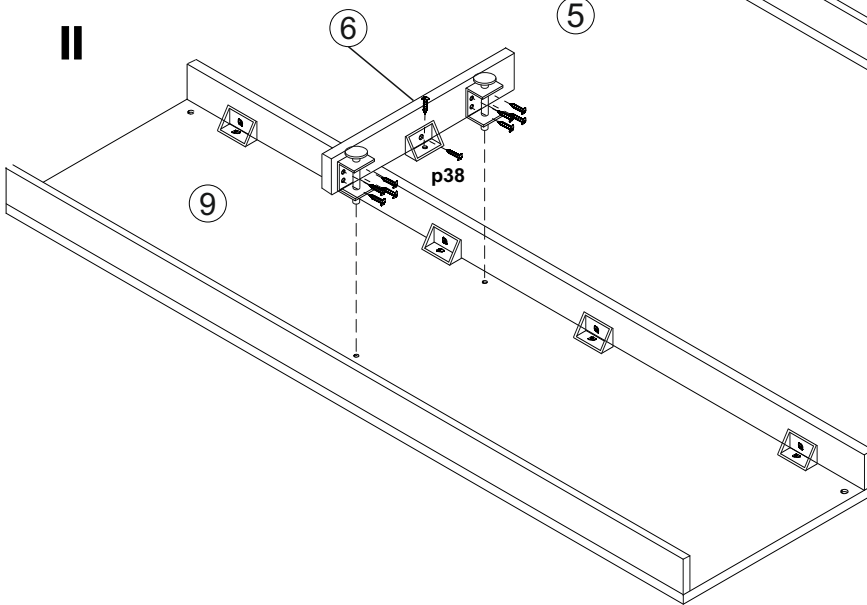

2

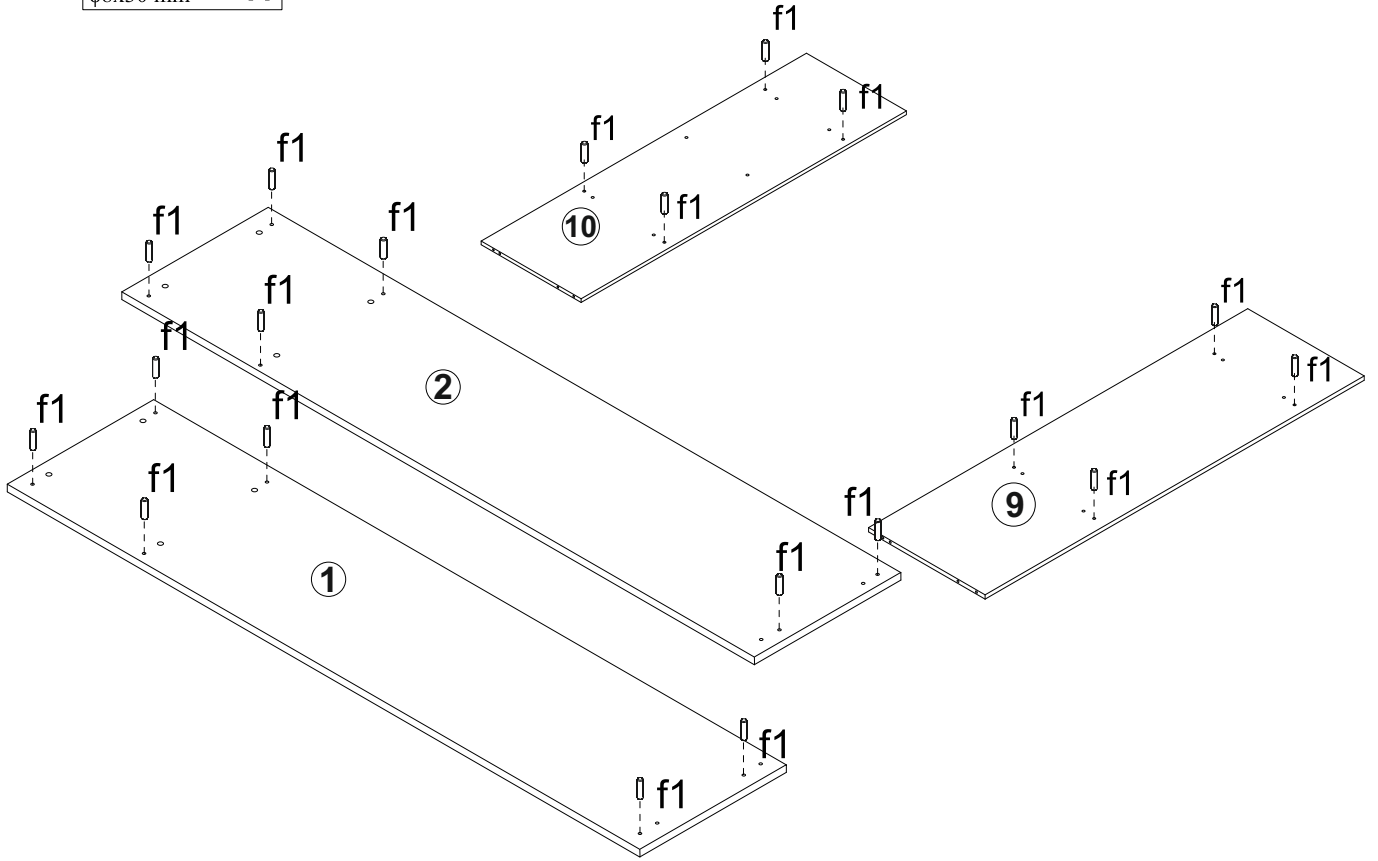
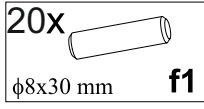

3

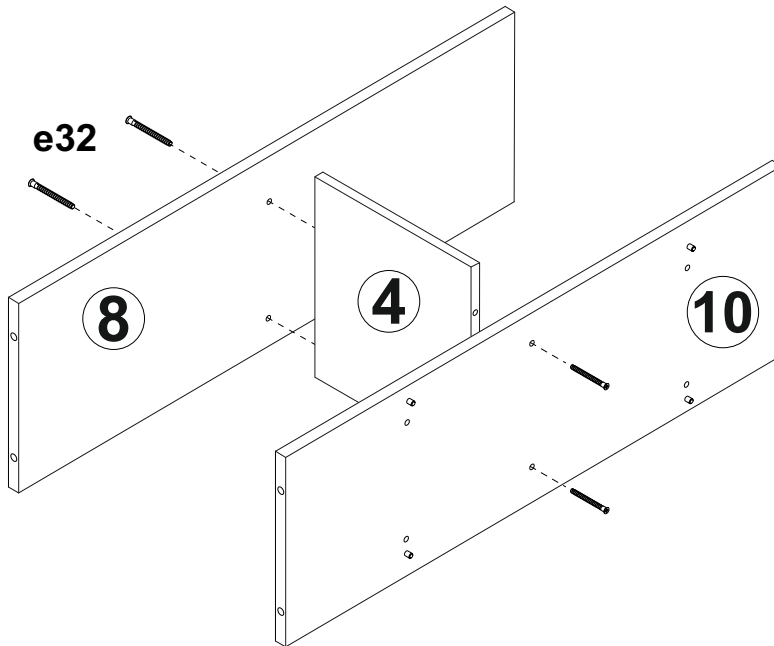
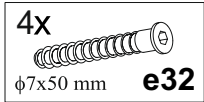

4

4x

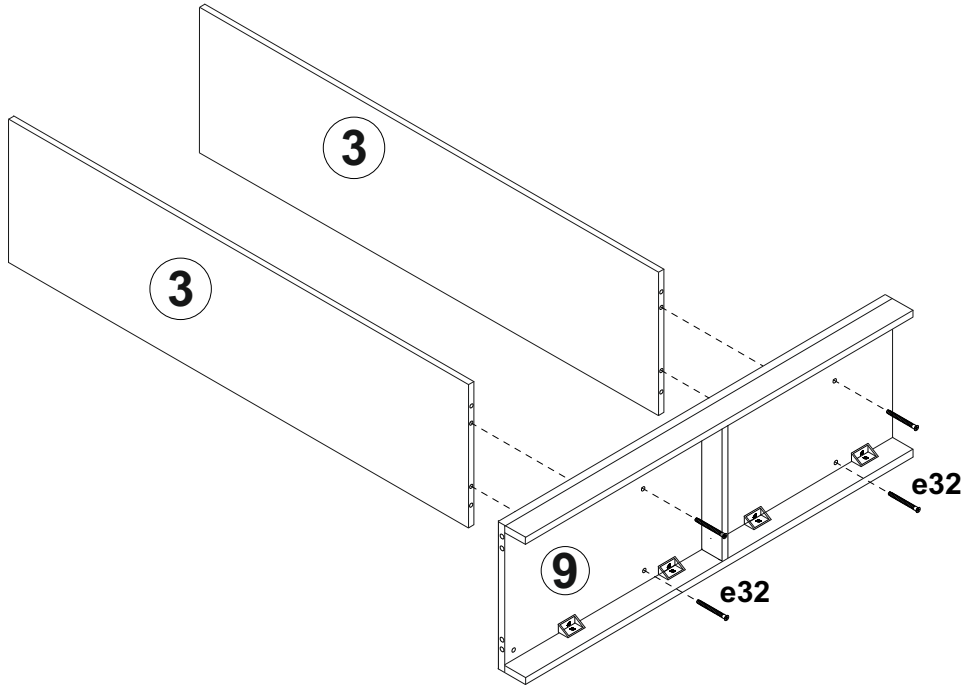
φ7x50 mm e32

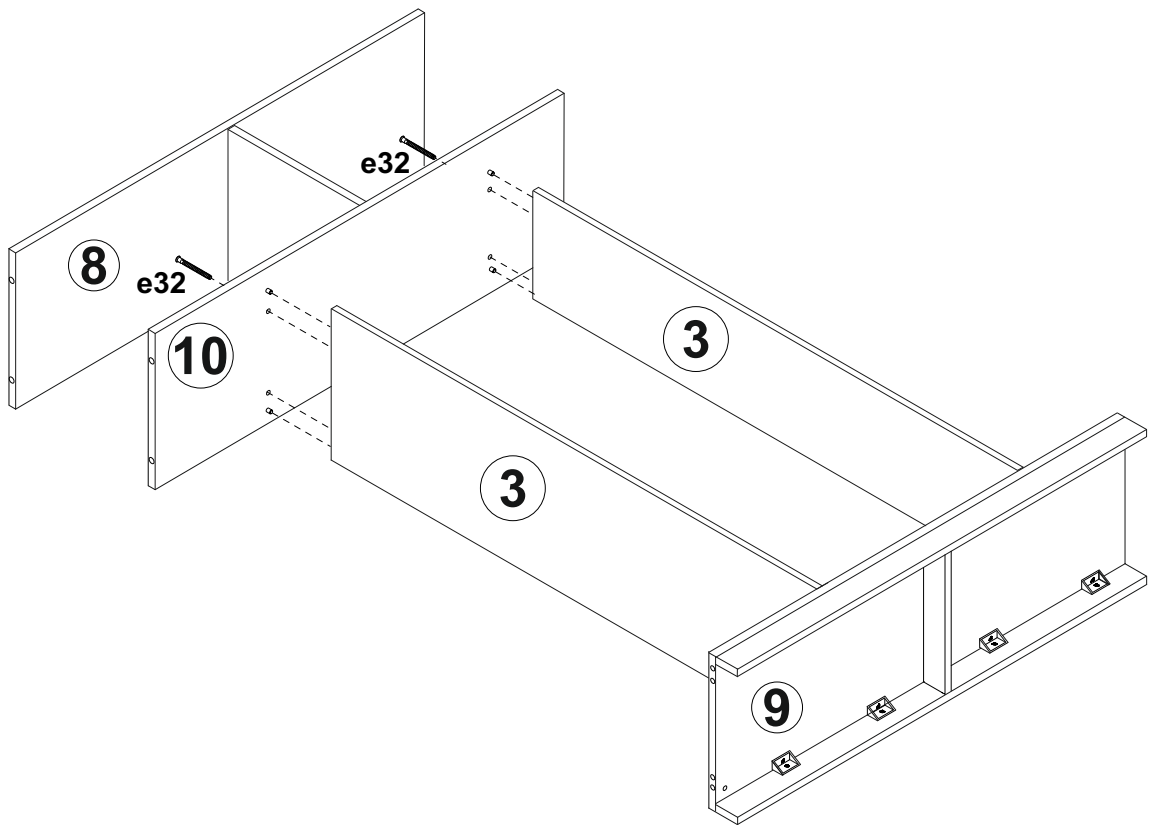

5

4x

φ7x50 mm e32

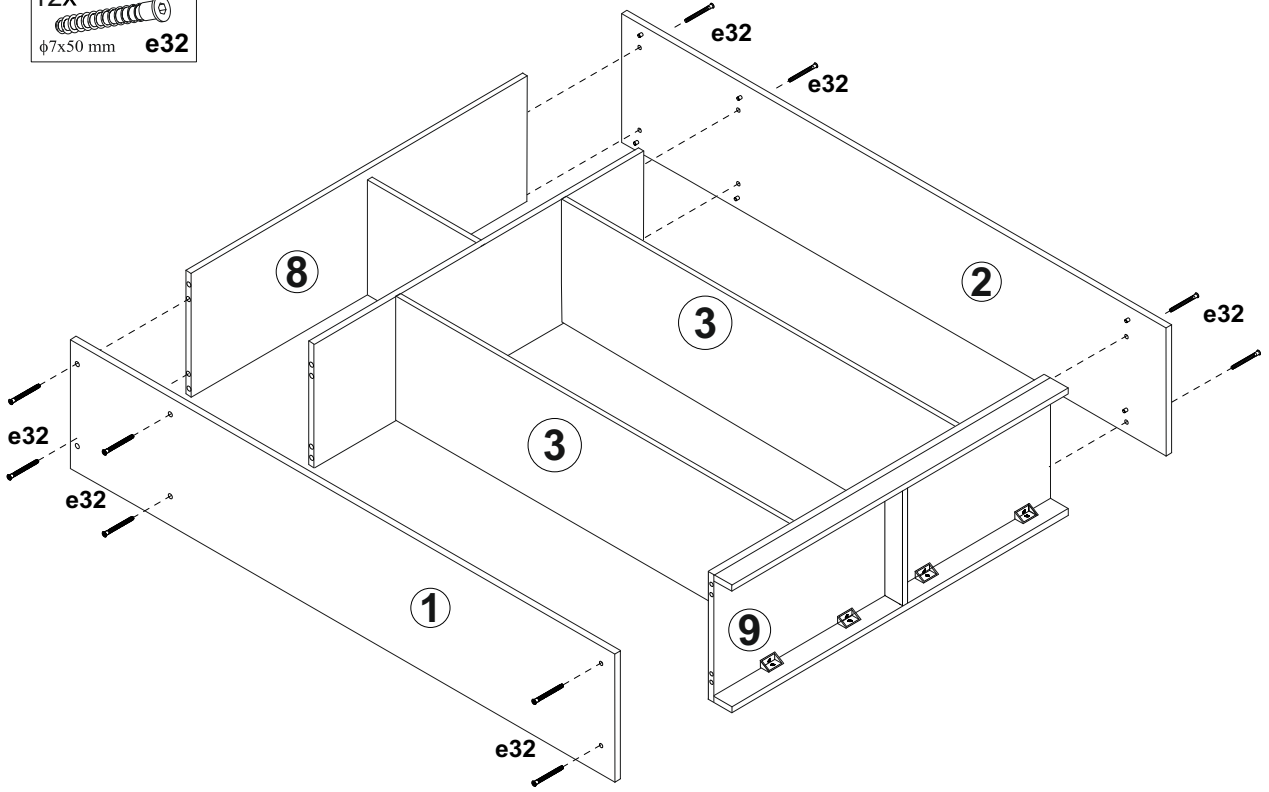

6

12x
φ7x50 mm e32



7

16x
φ3,5x16 mm p38

4x

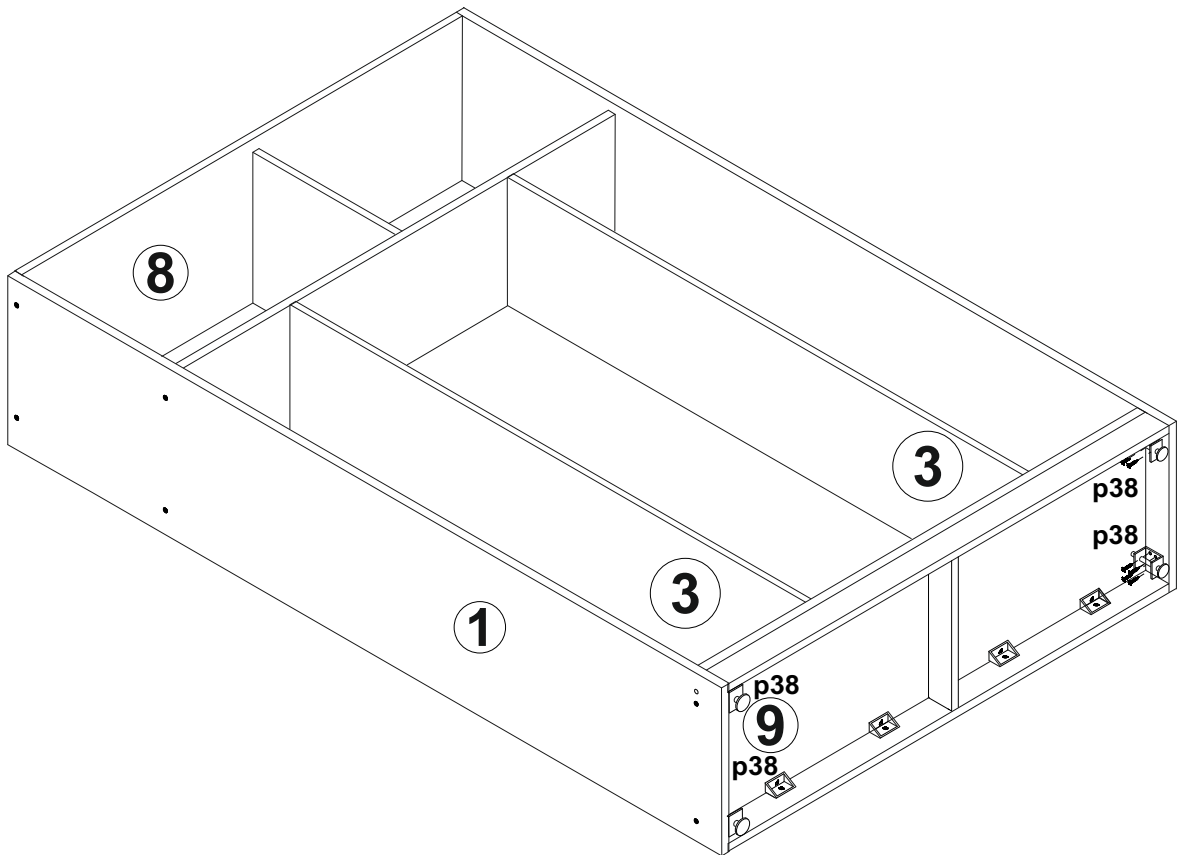

8

32x r11

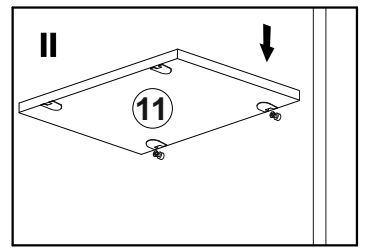
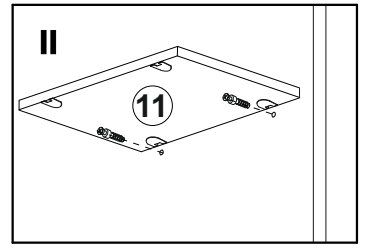
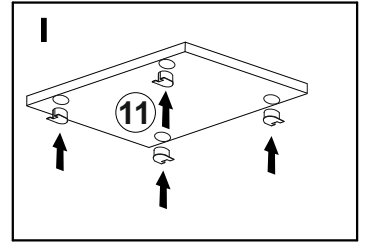
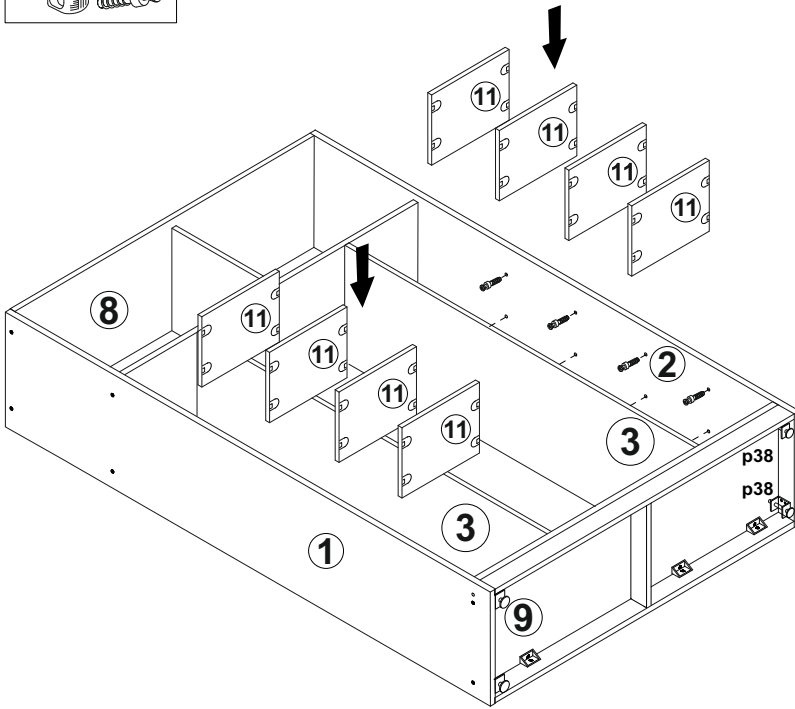

9

1x 26x zn1 24x $\phi 3,5 \times 16$ mm p38

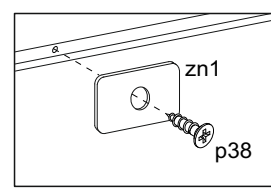
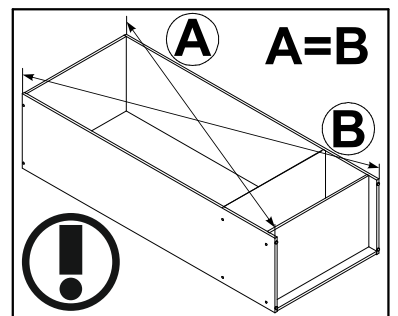
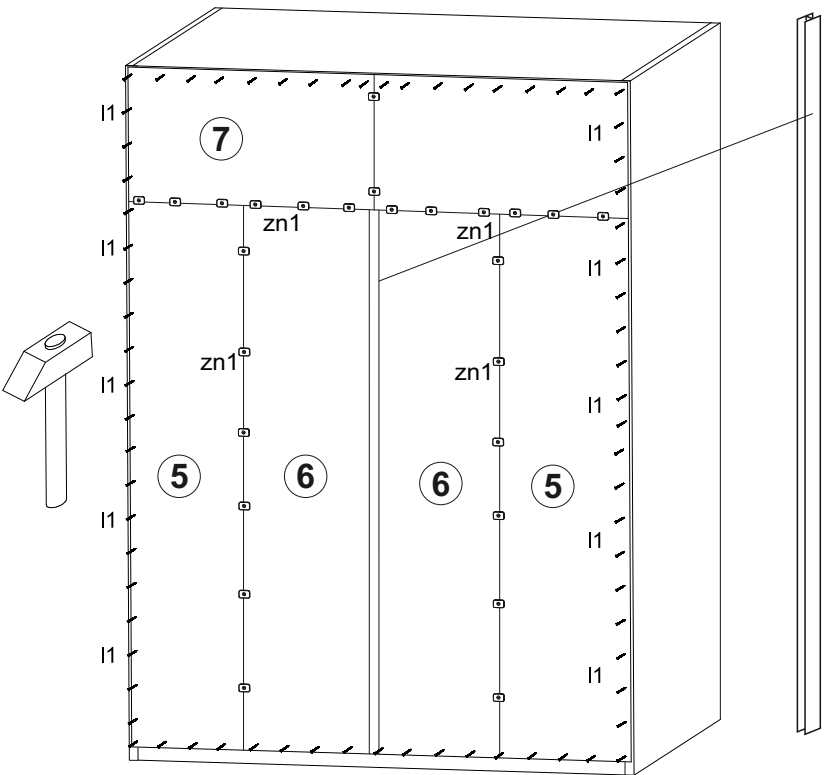
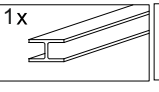
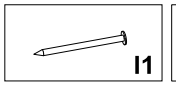

10

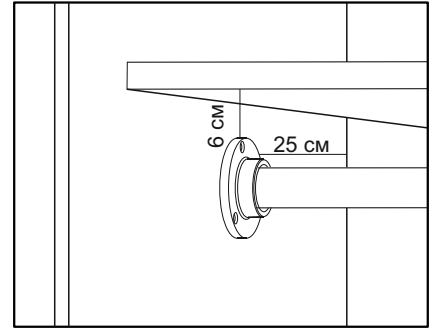
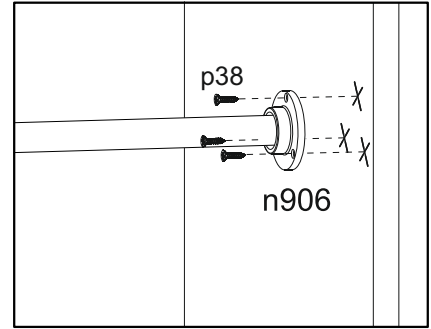
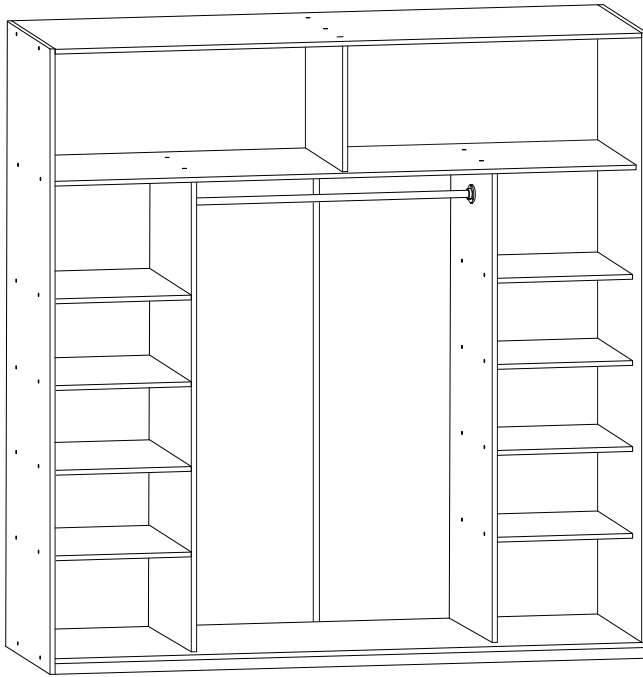

11

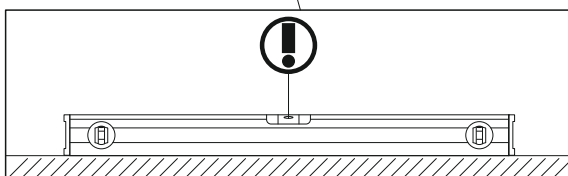
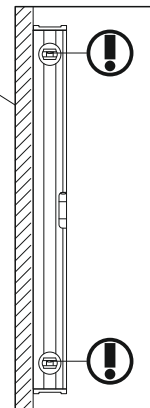
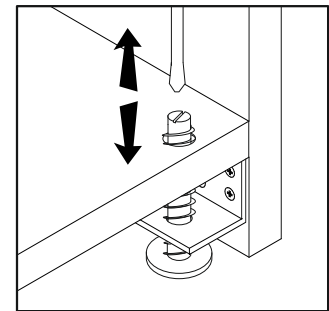
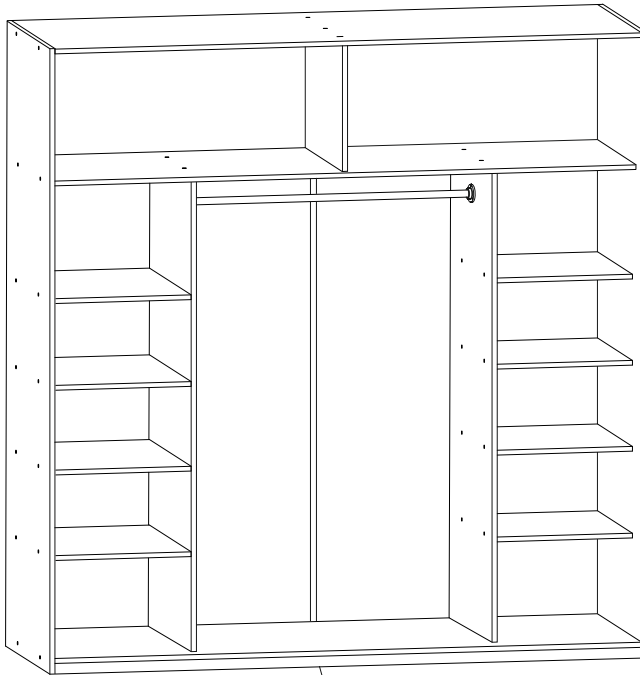

12

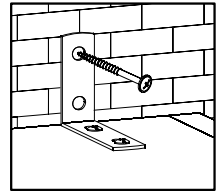
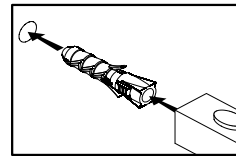
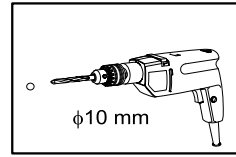
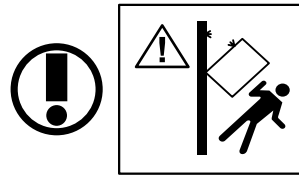
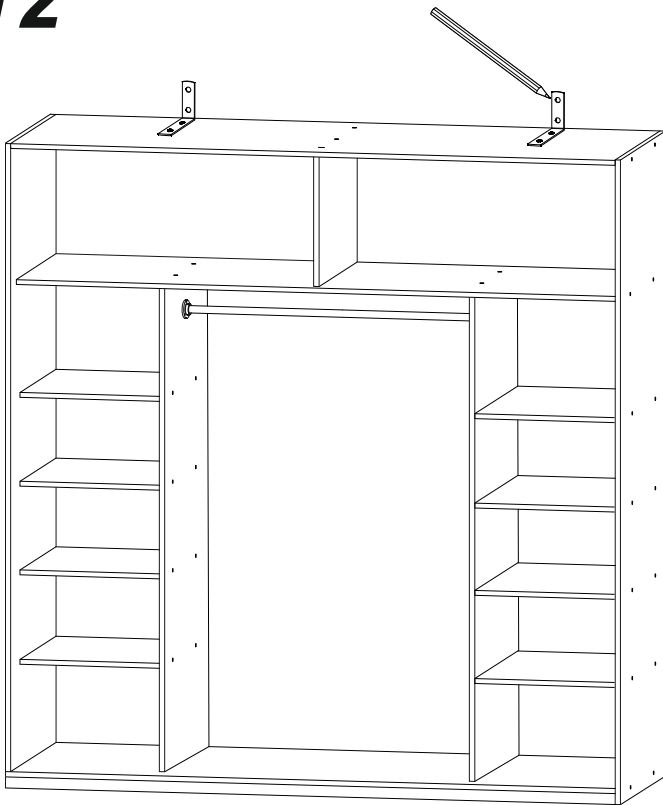



ENG

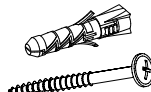

UA

The dowel and the wall mounting angle are not included. Purchase separately.

Дюбель та куток кріплення до стіни в комплект не входять. Необхідно придбати окремо.

13

4x

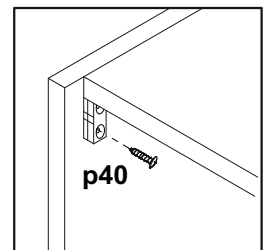
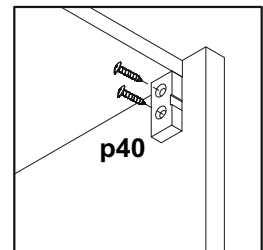
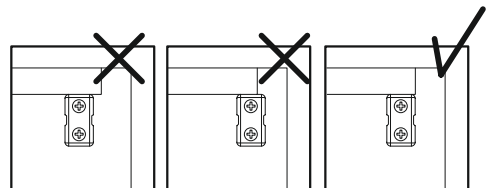
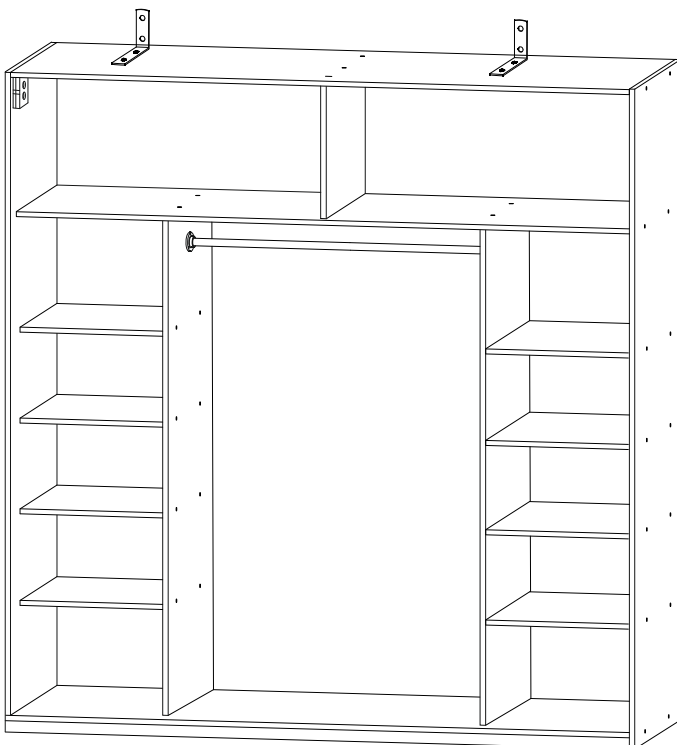
 φ4,0x25 mm p40

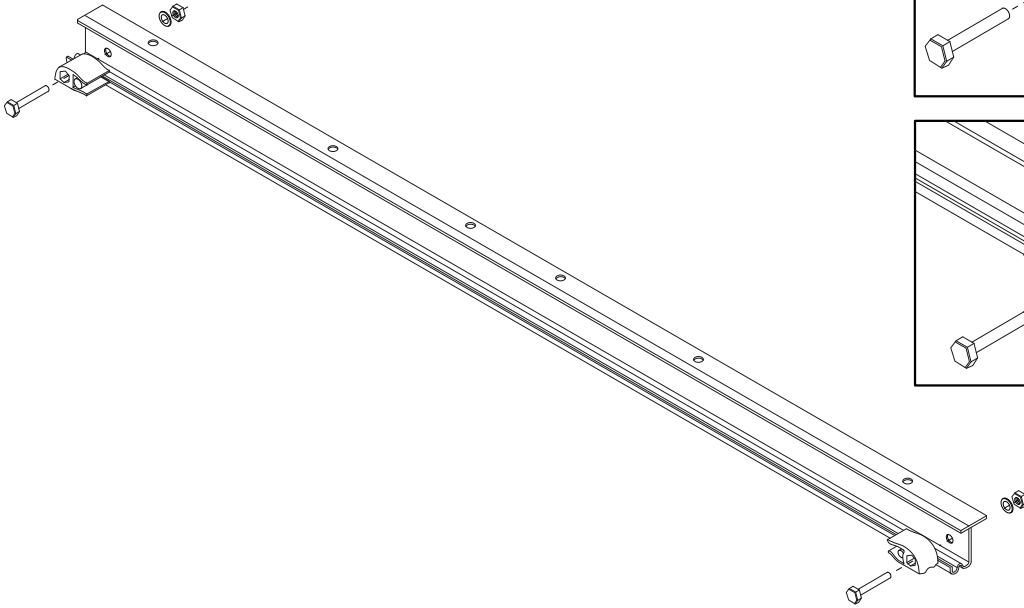

14

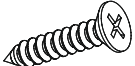

15

9x

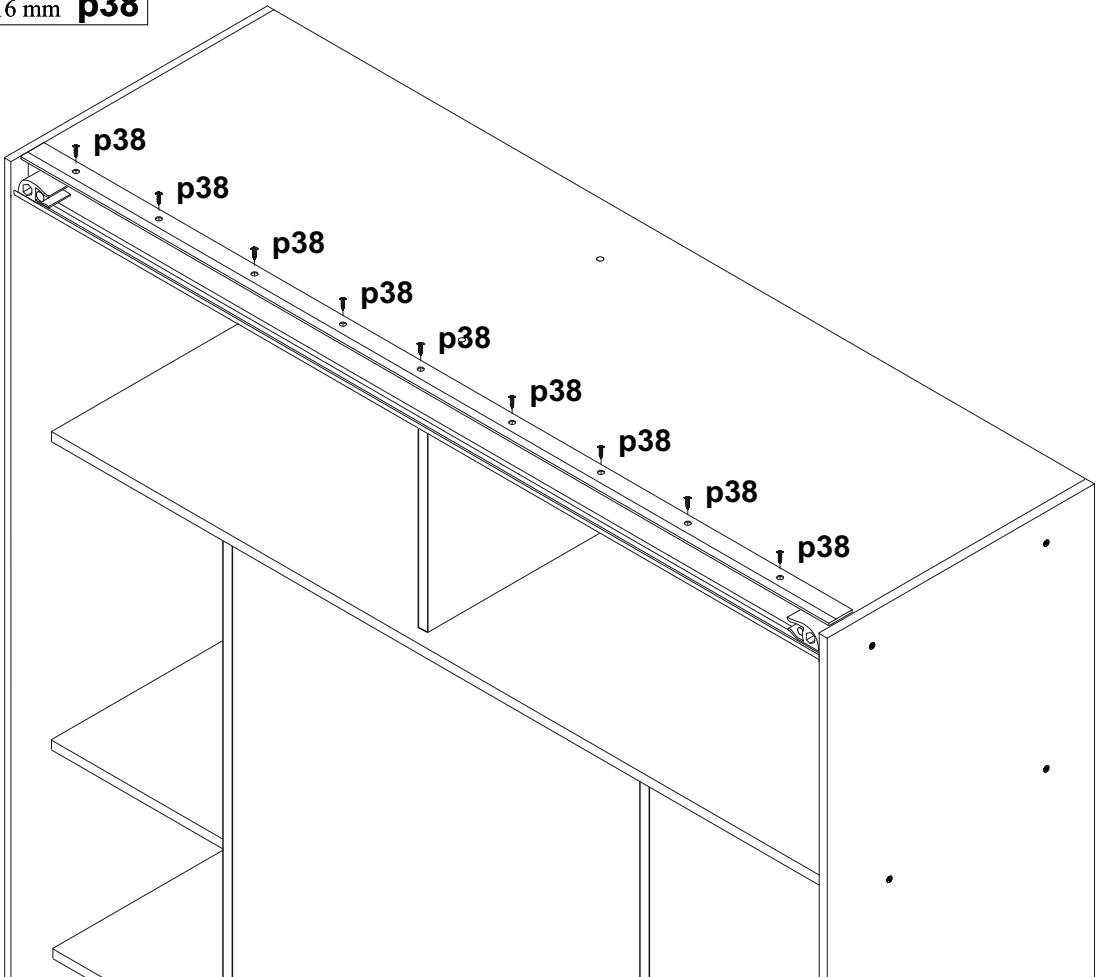
φ3,5x16 mm p38

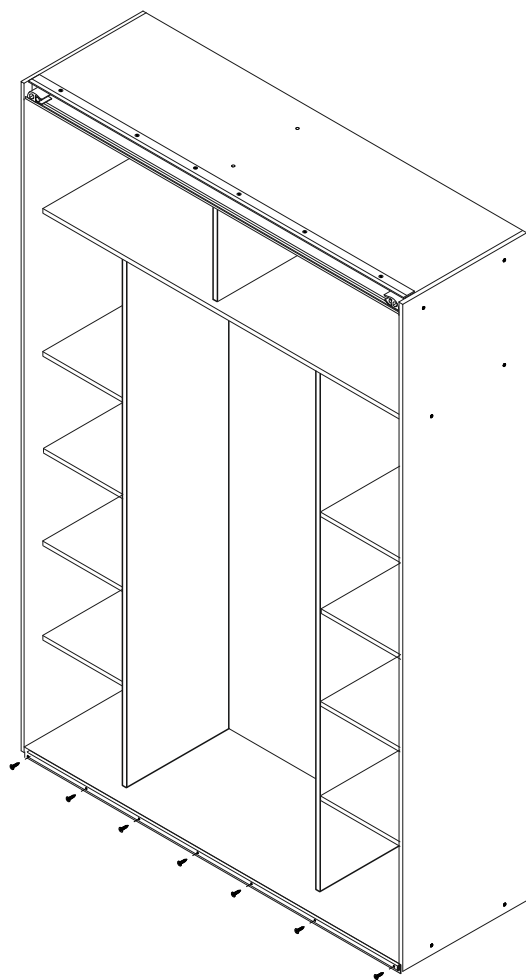
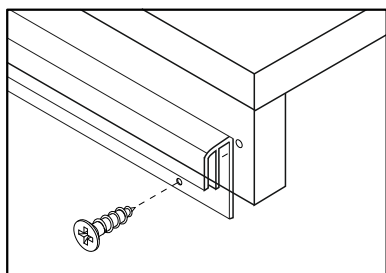
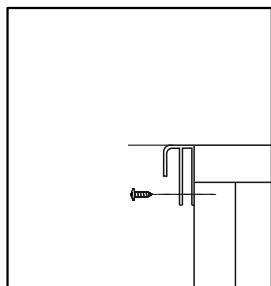
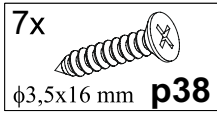

16

7x
φ3,5x16 mm p38





17

2x

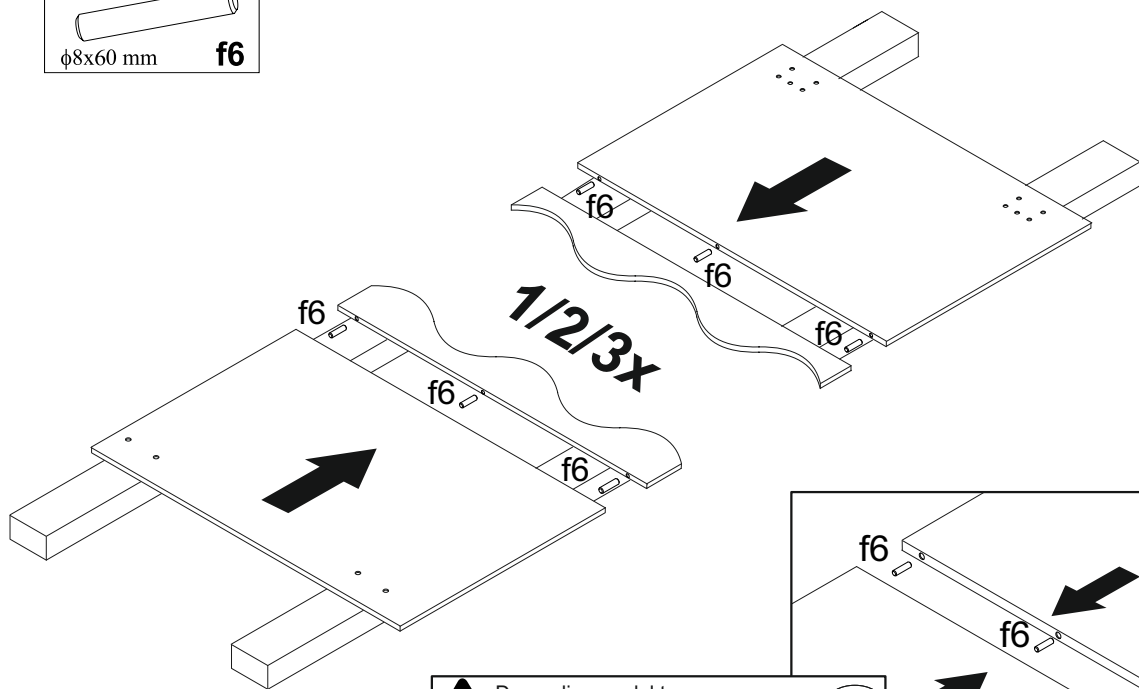
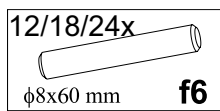
12/18/24x
φ8x60 mm f6



 Depending on model type
on the every joint of facades parts **ENG**

 Залежно від моделі
на кожному стику частин фасадів **UA**

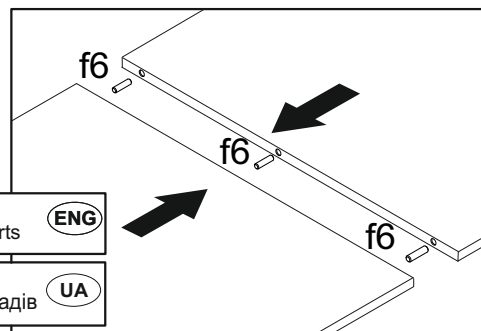

18
2x

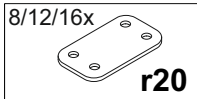
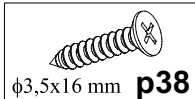

ENG Left facade
UA Фасад лівий

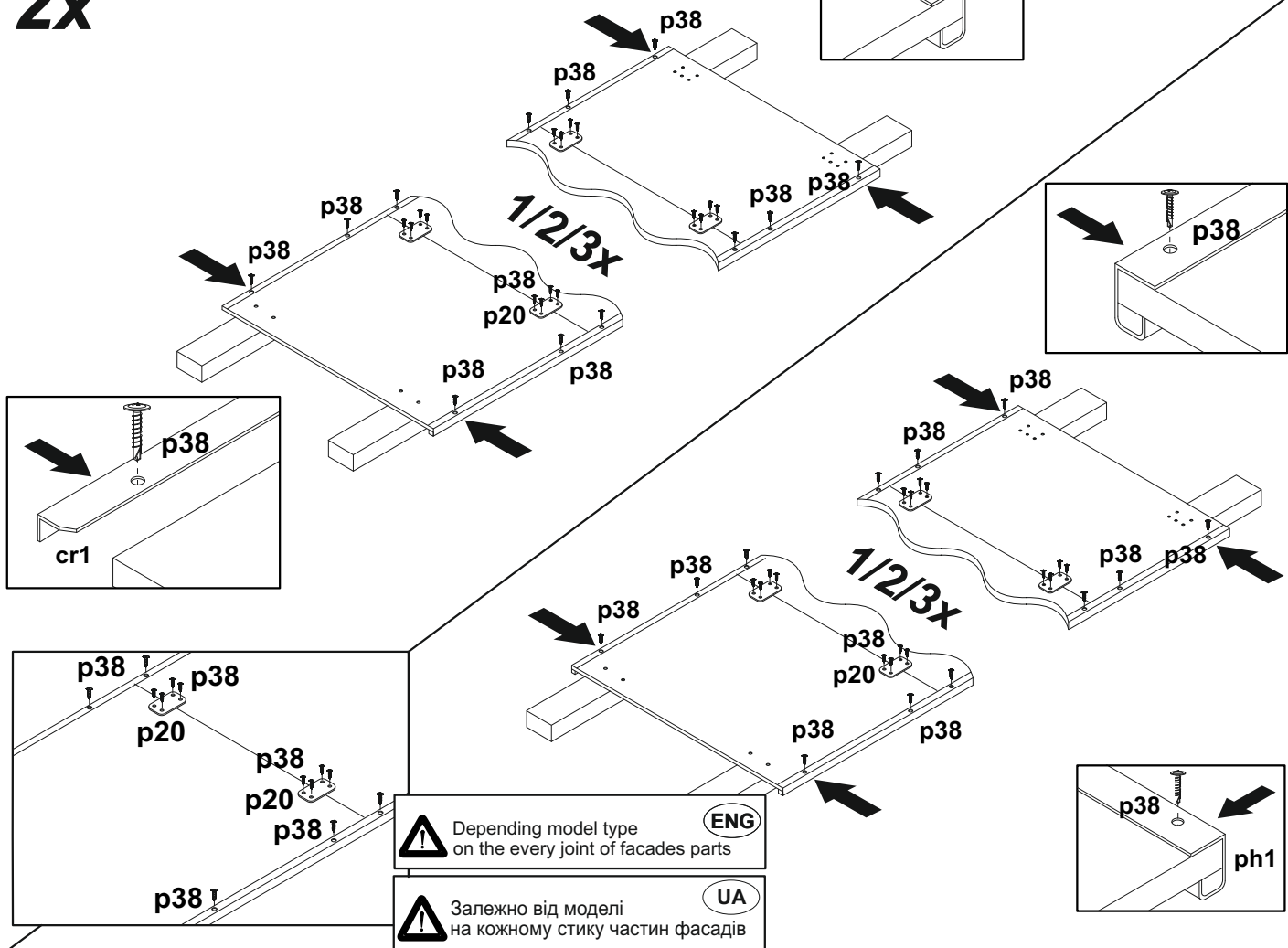

19

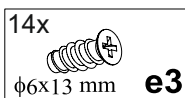

ENG Left facade
UA Фасад лівий

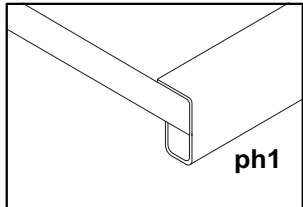
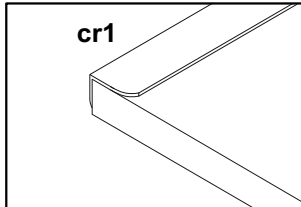
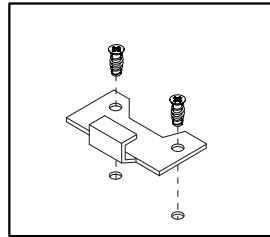
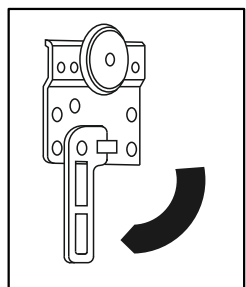
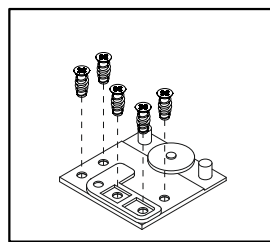
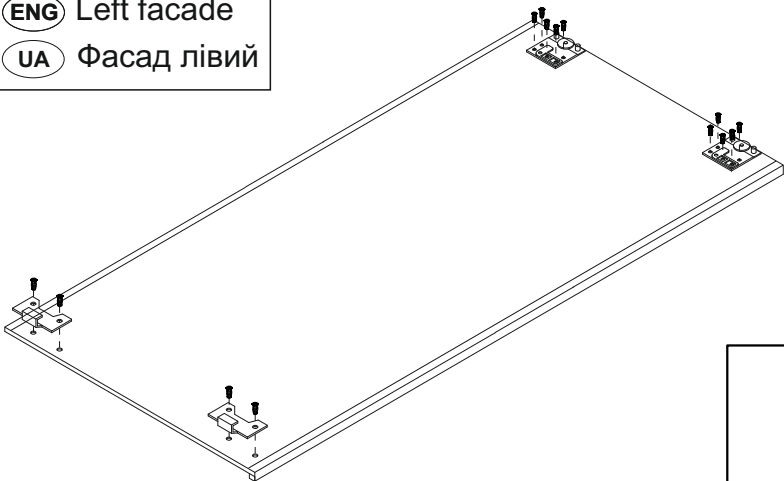

20

14x
φ6x13 mm e3

(ENG) Right facade
(UA) Фасад правий

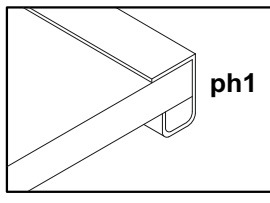
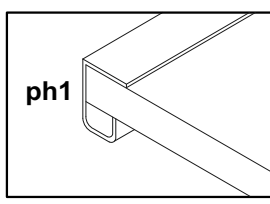
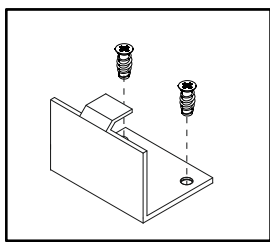
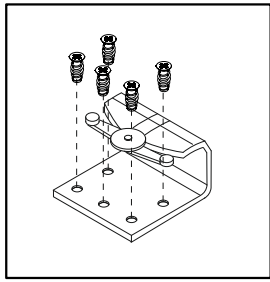
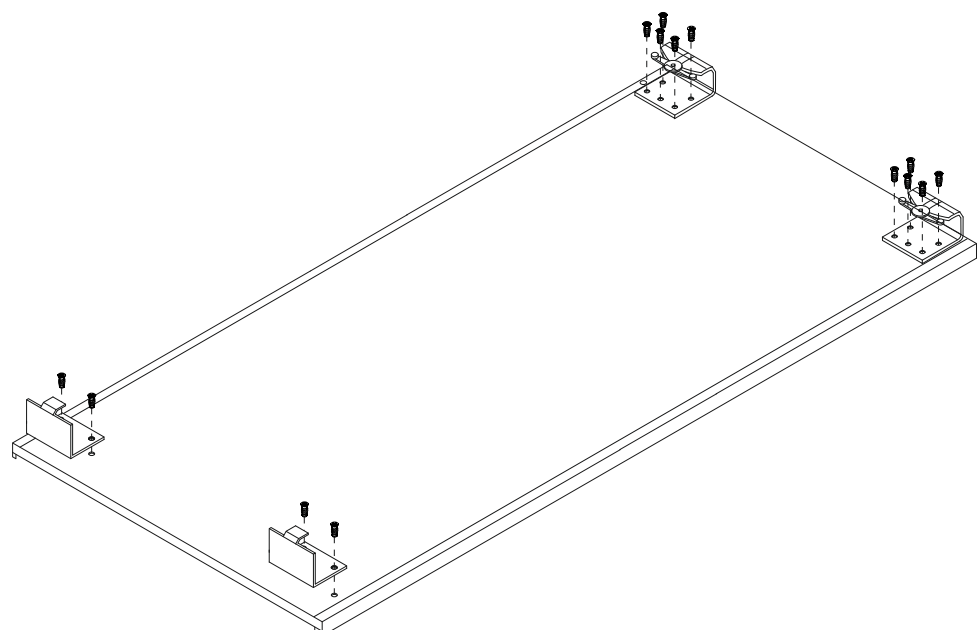

21

(ENG) Left facade
(UA) Фасад лівий

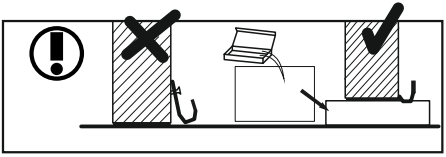
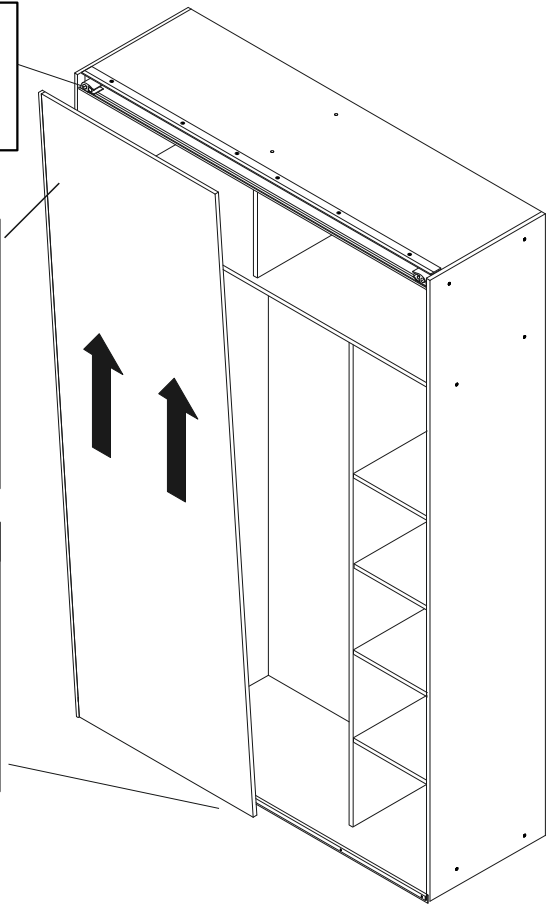
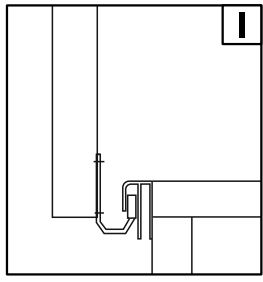
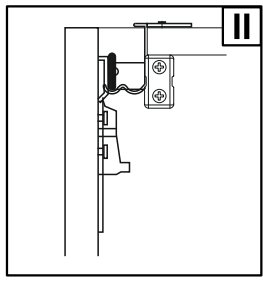
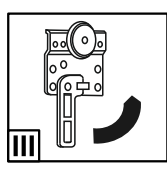

22

ENG Right facade
UA Фасад правий

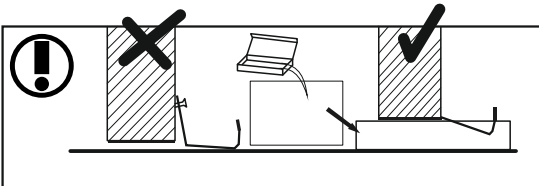
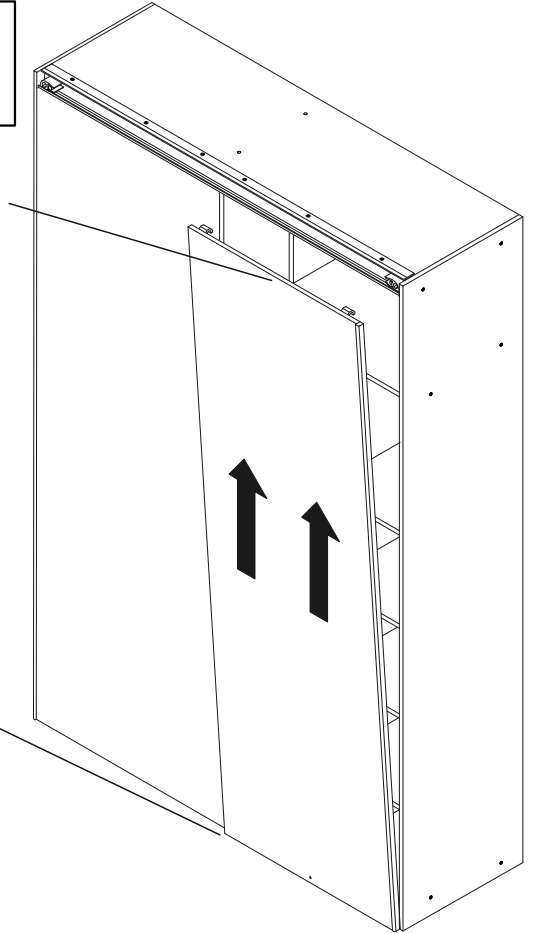
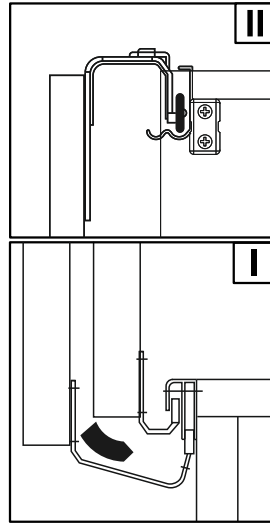
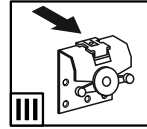

23

